



**Electronic Circulators for HVAC Systems
ECP-F Series
(Commercial-Flanged)**



Frequency Controlled, Electronic Circulation Pump

ECP-F series are intelligent efficiency circulation pump. Equipped with permanent magnet motor and intelligent pressure control system. It adopts canned structure, the motor stator is completely canned, the rotating parts are immersed in the conveying liquid, the liquid plays the role of cooling the motor and lubricating the bearings. The product has the characteristics such as no leakage, super quiet, energy saving, high efficiency etc.

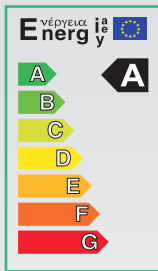

EEI ≤ 0.23



Commercial
Air Conditioning



Commercial
Heating



Domestic
Heating

Technical Specifications

Maximum Power	: Up to 1.523 W
Maximum Flow	: 68 m ³ /h
Maximum Head	: 18 m
System Pressure	: 10 Bar
Liquid Temperature	: -10 °C ~ +110 °C

Naming Detail

ECP 50 - 120 F 280 Blank N

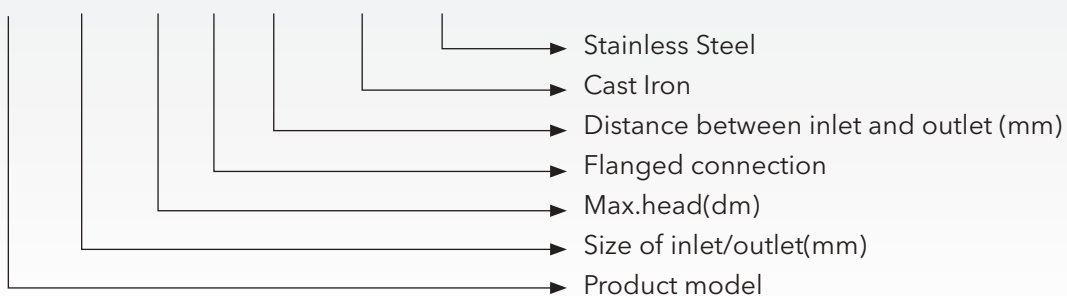

Precise Control, Multiple Protection

- High accuracy of the algorithm
- THD (Total Harmonics Distortion) 8%
- Power factor > 98%,
- Power detection accuracy $\pm 3\%$



Memory with
power restart



Fault
detection



Anti-seize
design



Overheat
protection



Overcurrent
protection

Pump Configuration

Motor	: High efficiency permanent magnet motor
Pump shaft	: Tungsten Carbide Alloy Stainless Steel
Bearing	: Ceramic
Impeller	: High temperature resistant composite material

Pump Features

- Class A energy efficiency, $EEI \leq 0.23$;
- Permanent magnet motor intelligent frequency control;
- Proportional pressure mode;
- Constant pressure mode;
- Constant speed mode;
- Low noise;
- No leakage.

Application Limits

- Installed in the heating circulation system;
- Operating Conditions:
- Ambient temperature: $0 \sim 40^{\circ}\text{C}$;
- Ambient humidity: $< 95\%$;
- Liquid temperature: $-10^{\circ}\text{C} \sim +110^{\circ}\text{C}$;
- The ambient temperature is lower than the liquid temperature to prevent condensate liquid inside the motor;
- Liquid material: non-corrosive, non-explosive liquid, no solid particles, fiber and mineral oil;
- Use requirements: Running can not no more than 10s without water.

Intelligent Control Saves Time And Energy



Constant pressure mode



Proportional pressure mode



Constant speed mode



AUTOADAPT mode



FLOWADAPT control mode



Temperature control mode

Constant Pressure Mode

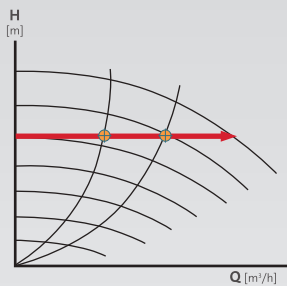

Constant pressure control is used to adjust pump performance based on actual system heat demand, but the pump performance curve will depend on the desired pump curve.

Proportional Pressure Mode

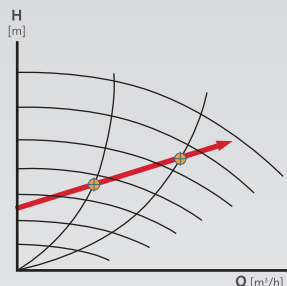

Proportional pressure control is used to adjust the pump performance according to the actual system heat demand, but the pump performance depends on the desired pump curve PP1, PP2 or PP3. Three gears are adjustable, namely small, medium and large.

Constant Speed Mode

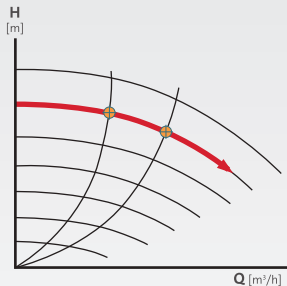

At constant speed, the pump runs at a constant speed, independent of the actual flow demand of the system, and the performance of the pump is determined according to the required power curve.

AUTOADAPT Mode

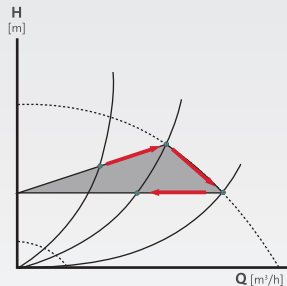

During operation, the system will regulate the performance of the pump according to the flow rate required by the user. The water pump is under proportional-pressure control. The system adaptively adjusts the pump performance within a certain area so that the pump works at a high efficiency.

FLOWADAPT Control Mode

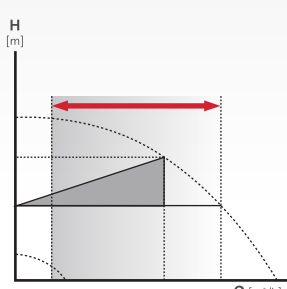

When the FLOWADAPT control mode is selected, the pump will run AUTOADAPT and ensure that the flow rate does not exceed the limited flow rate value. This control mode is suitable for systems that need to limit the maximum flow. Pumps in boiler applications where a steady flow through the boiler is required. No extra energy is used for pumping too much liquid into the system.

Temperature Control Mode

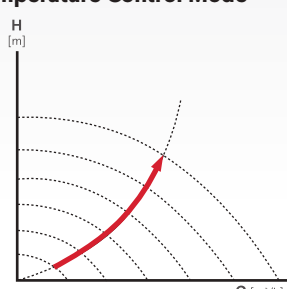

This control mode is suitable for systems with fixed system characteristic curves, and the pump can be controlled according to the temperature sensor feedback of the system to make it work under the working conditions required by the user.

Easy Adjustment, Control Function



HD display



LCD human-computer interaction interface



Convenient and clear human-computer interaction

User-Friendly Interface

Home Menu

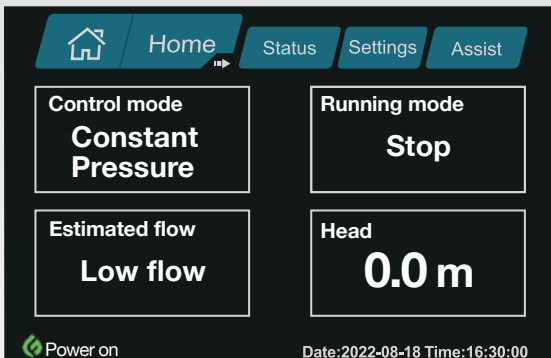

Status Menu

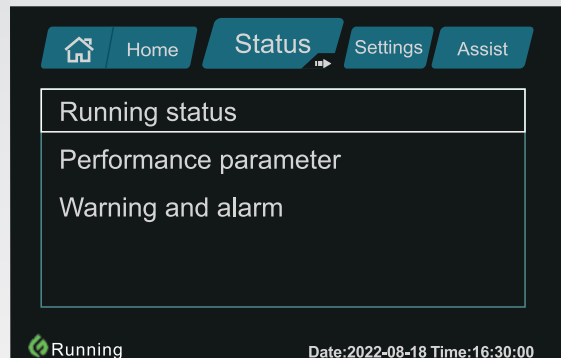

Setting Menu

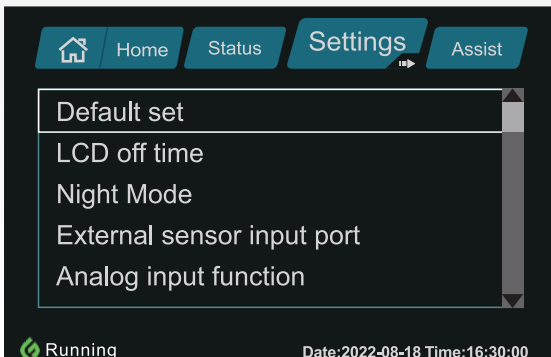

Assist Menu

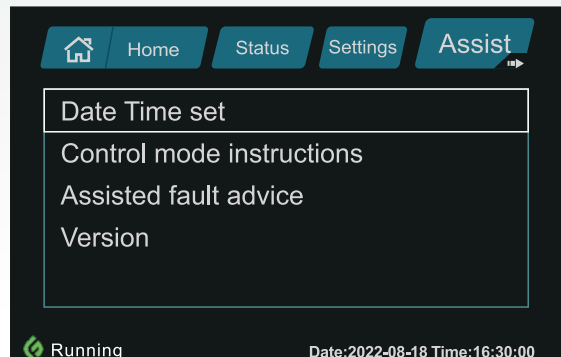

Pump Material Detail

This product has three advantages: PES engineering plastic impeller, tungsten carbide treated stainless steel rotor shaft, and high power permanent magnet synchronous motor.

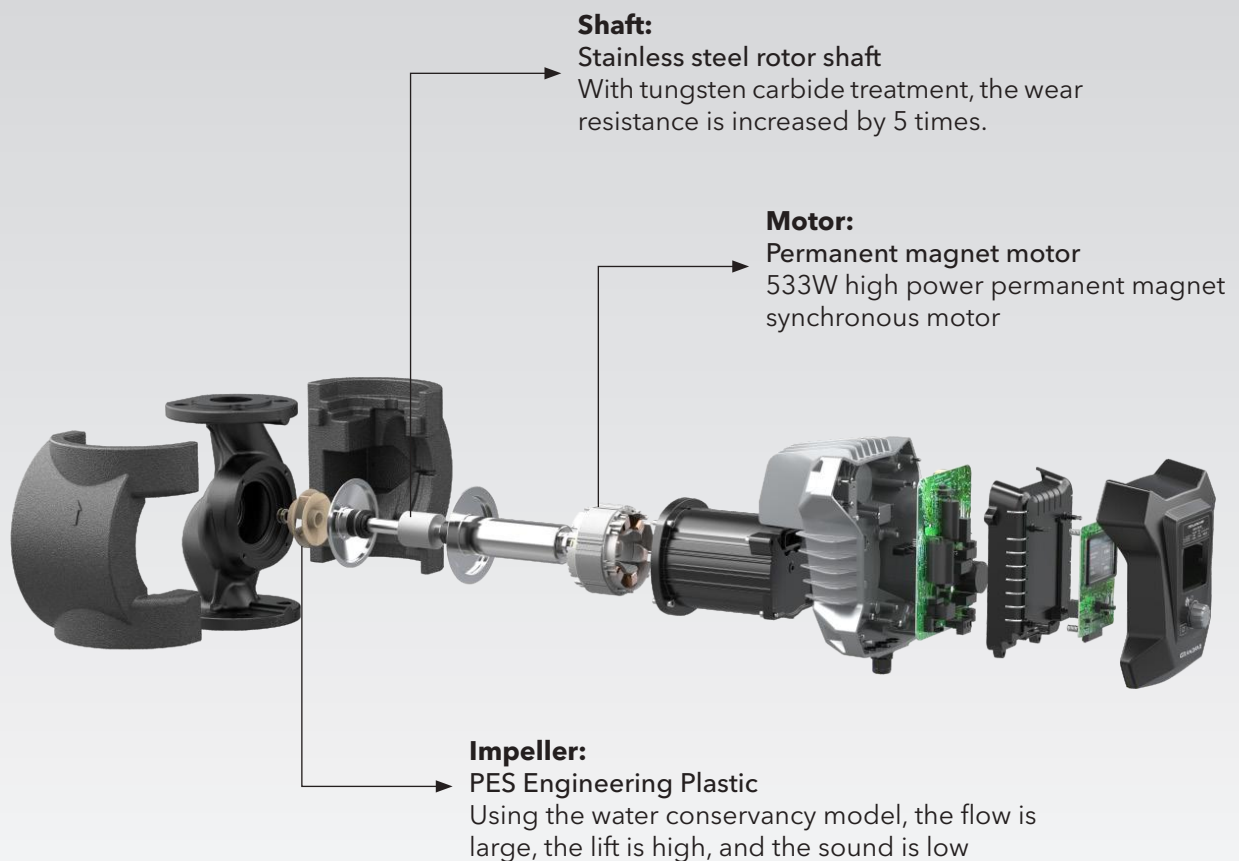

PES Engineering Plastic Impellers



Permanent magnet motor



Stainless steel rotor shaft

Material Specifications

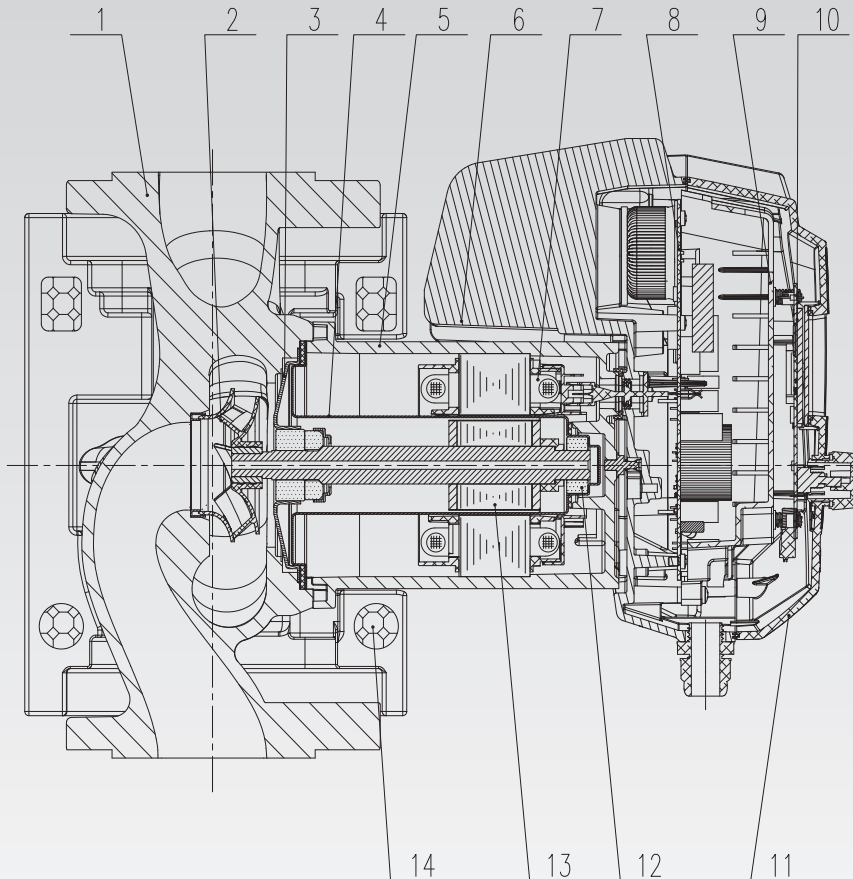

POS.	COMPONENT	CONSTRUCTION CHARACTERISTICS
1	Pump Head	Cast iron surface electrophoresis treatment, exterior painting treatment
2	Impeller	Hydraulic model, equipped with PES engineering plastic impeller
3	Stainless Steel Cover	Stainless steel material
4	Shielding Sleeve	Stainless steel material, the inner wall is mirror-finished
5	Barrel	Aluminum alloy barrel, the surface is treated with black electrophoresis.
6	Casing	Plastic spray outside
7	Stator	Full copper wire
8	Driver	Electronic device
9	Control Board	Electronic device
10	Isolation Shield	Black plastic
11	Cover	Using high-strength plastic, surface skin texture treatment, secondary vulcanization treatment of sealant, beautiful and fashionable appearance
12	Bearing	Brown ceramic
13	Rotor	Stainless steel shaft + tungsten carbide spray treatment
14	Foam	Black EPP material, with the characteristics of heat preservation and safety protection.

Performance Chart

Model	Nominal voltage (V)	Power frequency	Input power	Max. Current	Max. Flow rate (m ³ /h)	Max. discharge height (m)	Max. Pressure	Distance Between Flanges (mm)
ECP 32-120F 220(N)	1 x 230 V	50 / 60 Hz	15 .. 329 W	0.17 .. 1.48 A	11	12	PN6/10	220
ECP 40-120F 250(N)	1 x 230 V	50 / 60 Hz	15 .. 463 W	0.18 .. 2.05 A	24	12	PN6/10	250
ECP 40-150F 250(N)	1 x 230 V	50 / 60 Hz	16 .. 615 W	0.18 .. 2.71 A	26.2	15	PN6/10	250
ECP 50-80F 240(N)	1 x 230 V	50 / 60 Hz	21 .. 331 W	0,22 .. 1,48 A	27	8	PN6/10	240
ECP 50-120F 280(N)	1 x 230 V	50 / 60 Hz	20 .. 533 W	0.22 .. 2.37 A	33	12	PN6/10	280
ECP 50-180F 280(N)	1 x 230 V	50 / 60 Hz	22 .. 769 W	0.24 .. 3.4 A	37.5	18	PN6/10	280
ECP 65-100F 340(N)	1 x 230 V	50 / 60 Hz	25 .. 619 W	0,26 .. 2,73 A	44	10	PN6/10	340
ECP 65-150F 340(N)	1 x 230 V	50 / 60 Hz	31 .. 1263 W	0.31 .. 5.53 A	56	15	PN6/10	340
ECP 80-120F 360	1 x 230 V	50 / 60 Hz	31 .. 1277 W	0,28 .. 3,16 A	60	12	PN6	360

Communication interface: with Modbus communication

ECP32-120F

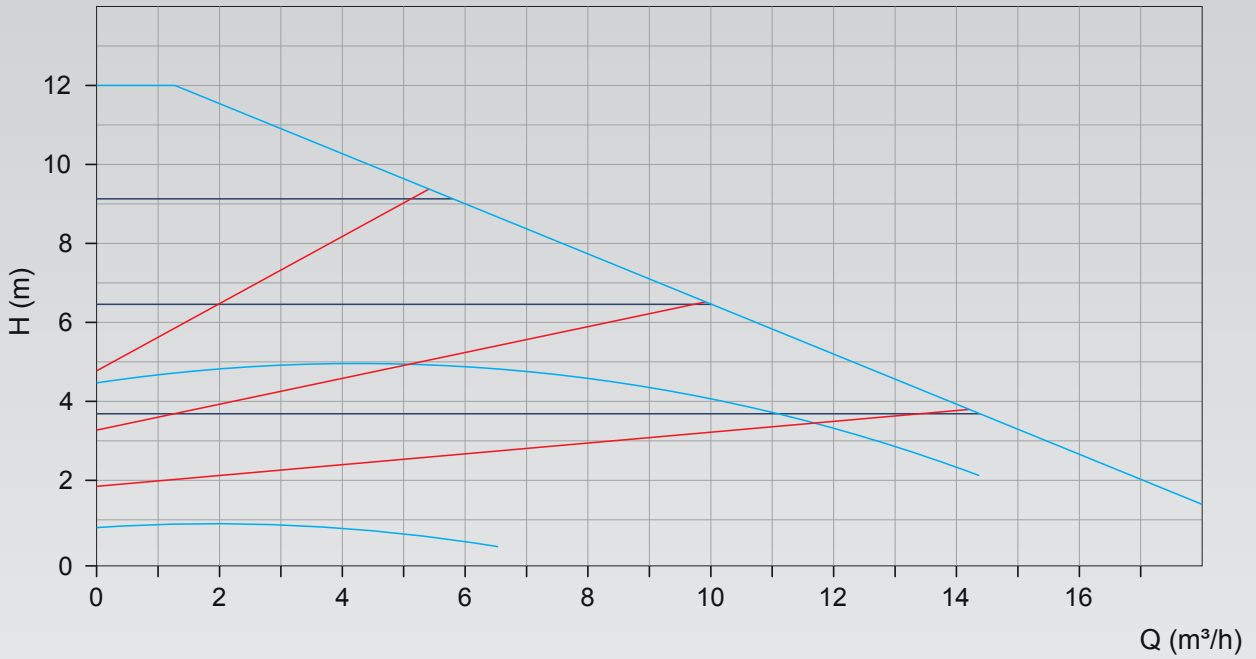

ECP40-120F

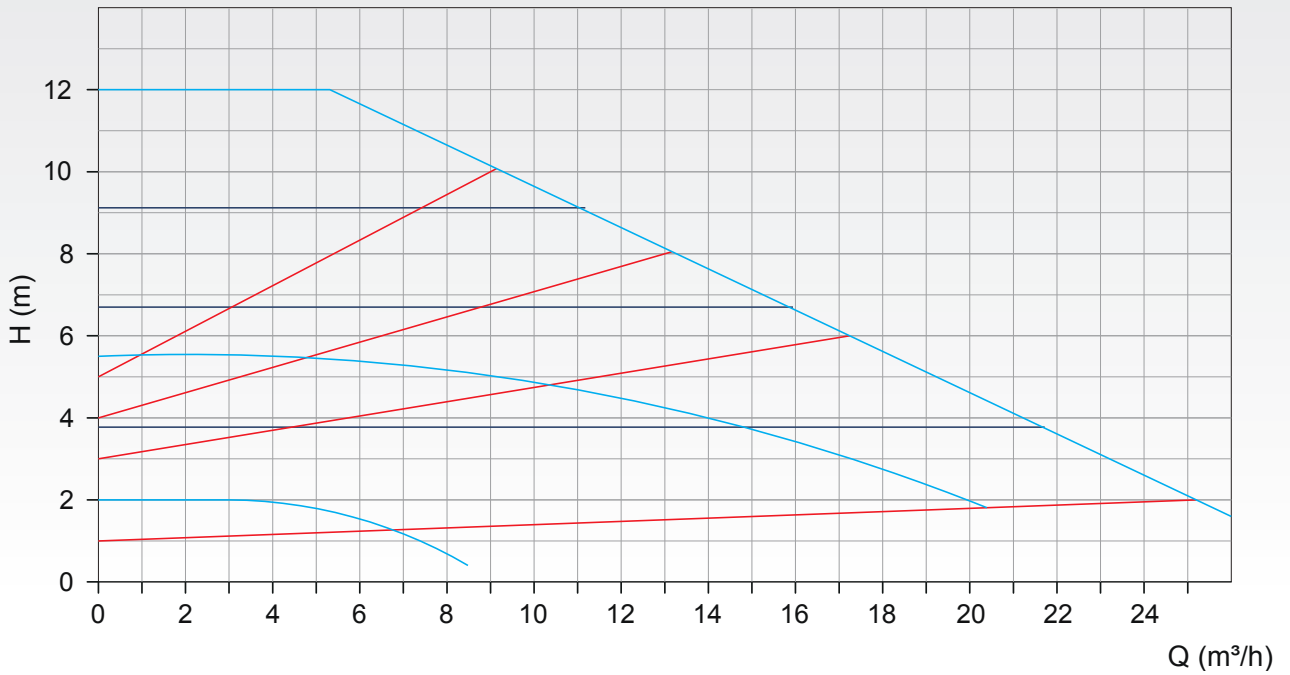

■ Proportional Pressure
 ■ Constant Pressure
 ■ Constant Speed

Performance Curves

ECP40-150F

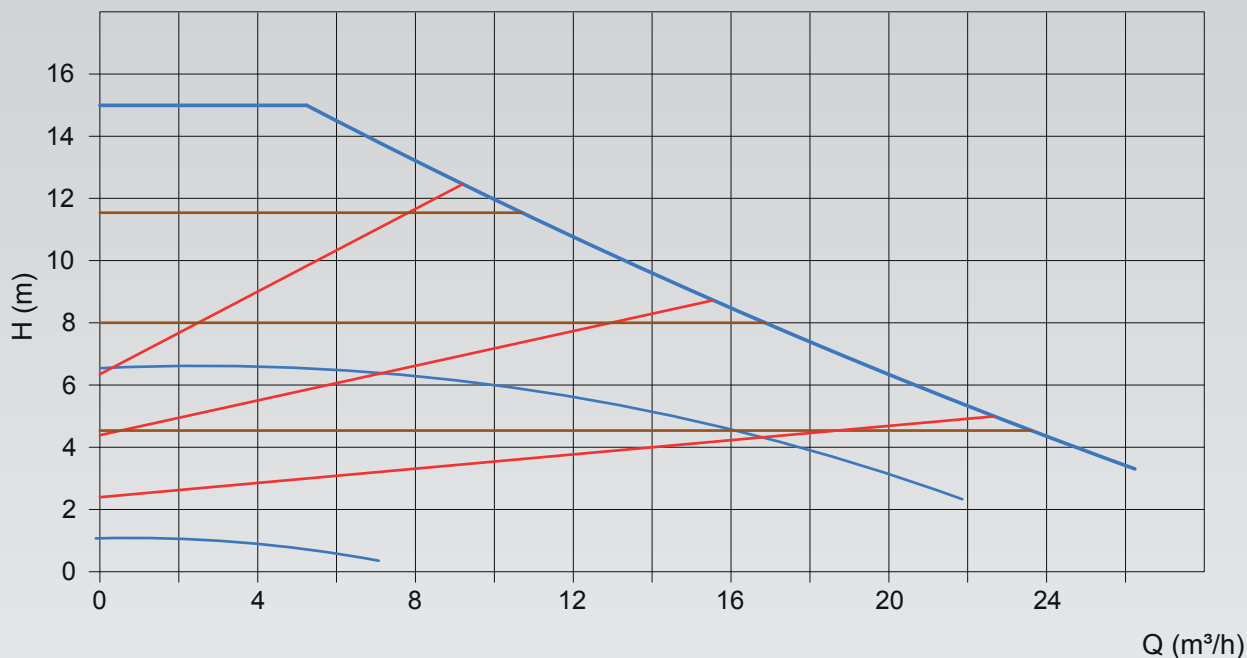

ECP50-80F

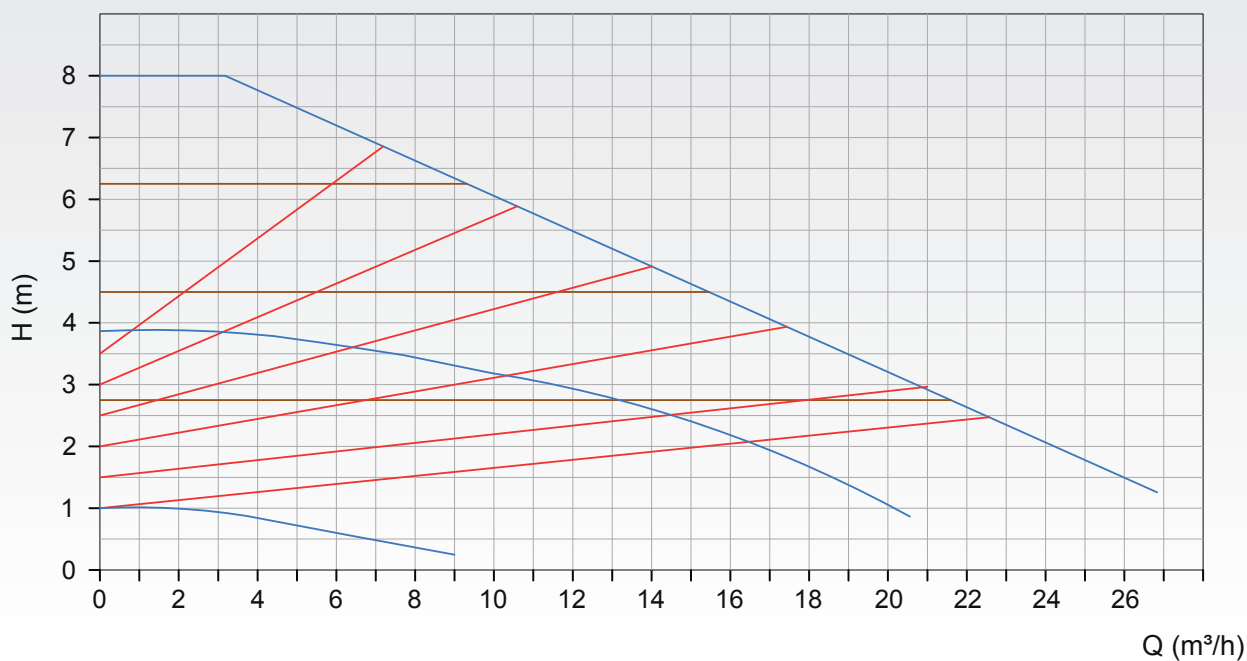

■ Proportional Pressure
 ■ Constant Pressure
 ■ Constant Speed

ECP50-120F

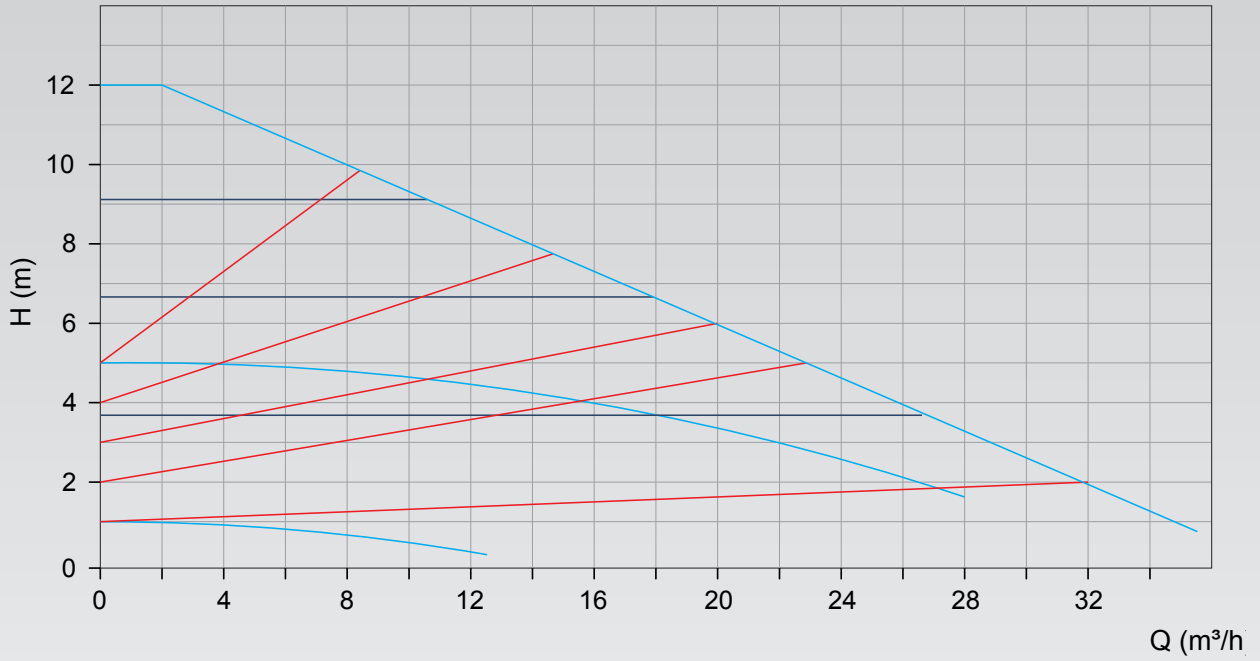

ECP50-180F

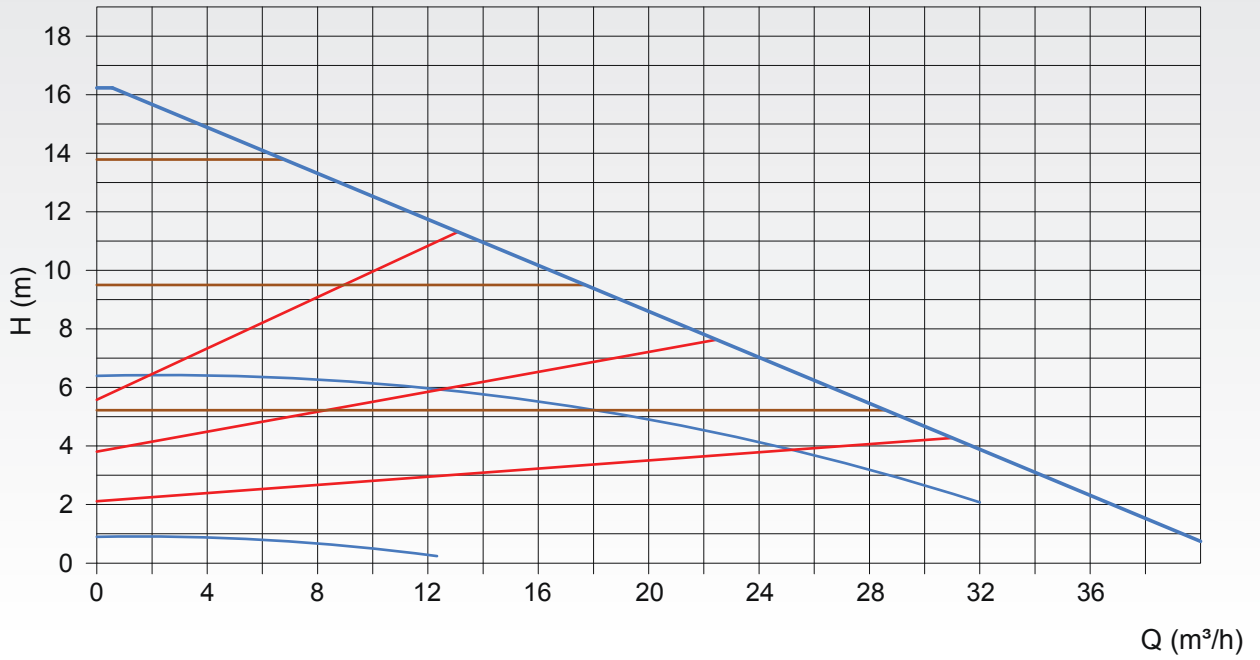

■ Proportional Pressure ■ Constant Pressure ■ Constant Speed

Performance Curves

ECP65-100F

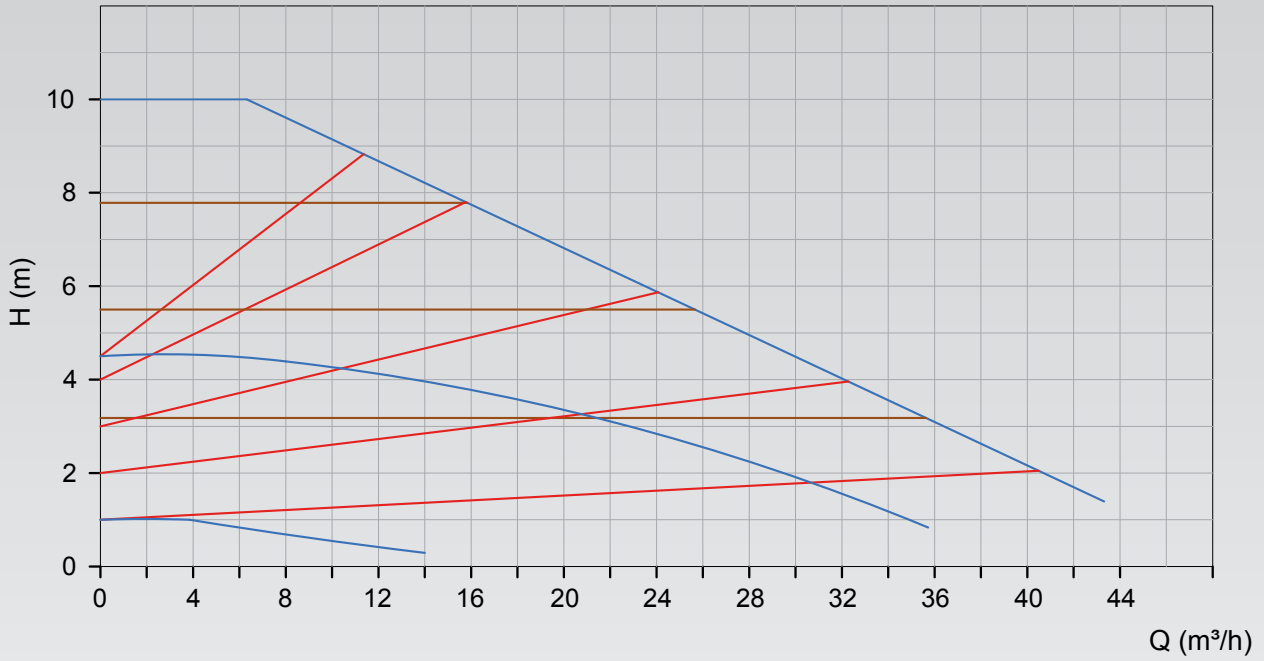

ECP65-150F

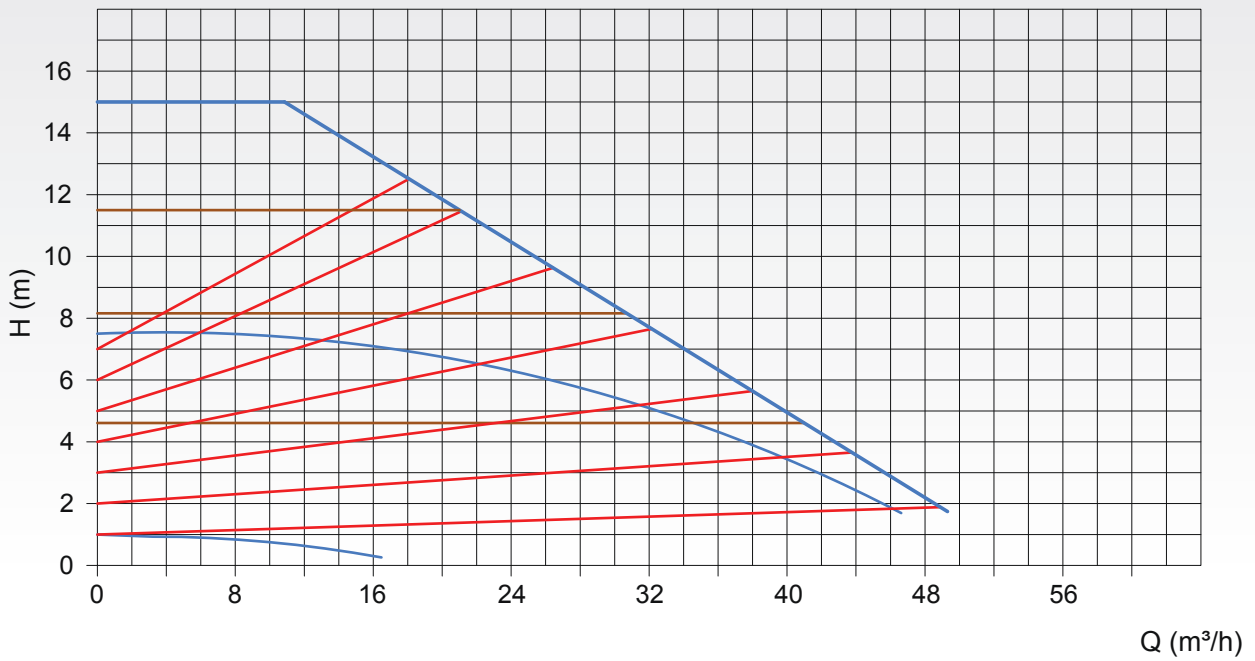

■ Proportional Pressure
 ■ Constant Pressure
 ■ Constant Speed

ECP80-120F

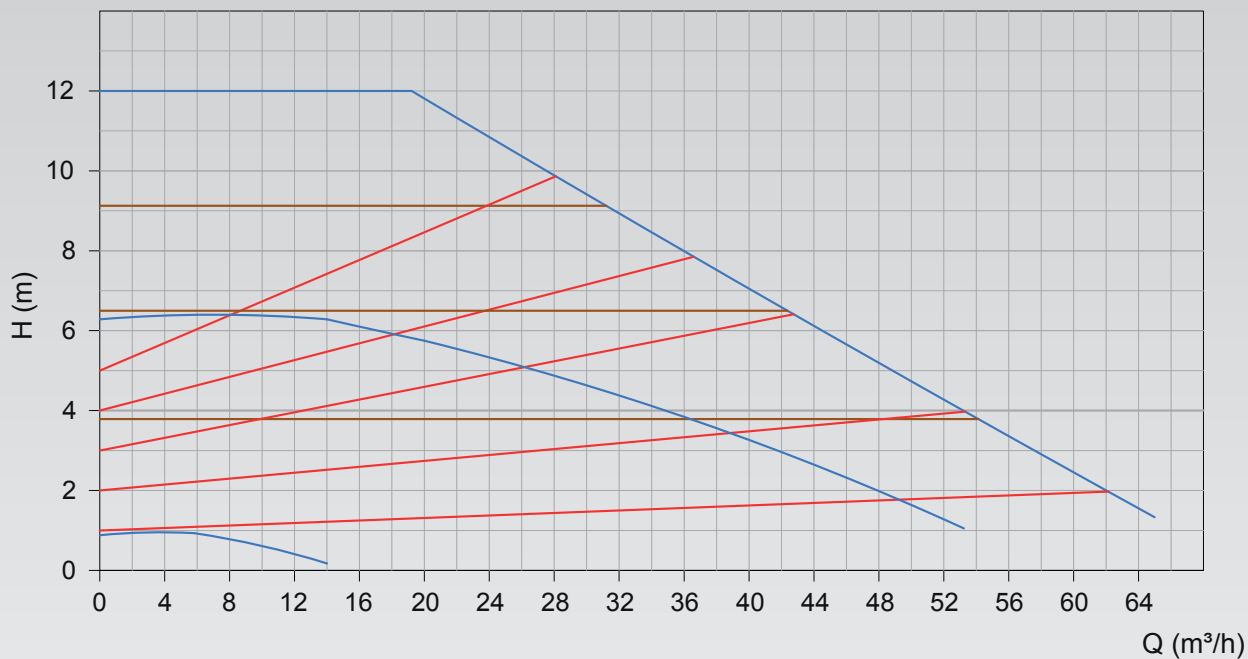

■ Proportional Pressure
 ■ Constant Pressure
 ■ Constant Speed

Installation Dimensions

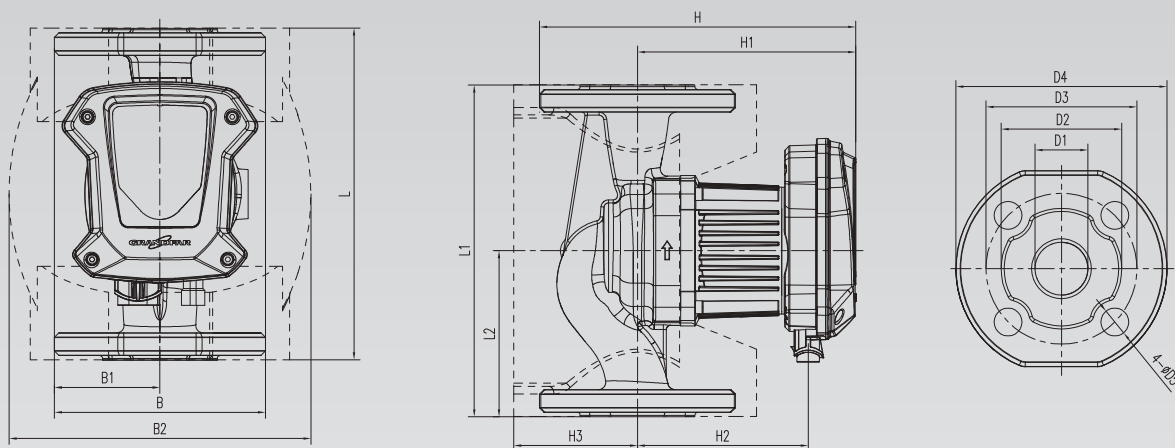

Model	Pump body material		Dimensions (mm)																G.W (kg)	N.W (kg)	Outer box L×W× H(mm)
	Cast iron	Stainless steel	L	L1	L2	B	B1	B2	H	H1	H2	H3	D1	D2	D3	D4	D5	N			
ECP 32-120F 220(N)	●	●	266	220	110	226	113	212	379	312	242	79	32	76	90/100	140	14/19	4	16,4	15,1	295×249×420
ECP 40-120F 250(N)	●	●	281	250	125	226	113	212	382	312	242	79	40	84	100/110	150	14/19	4	17,2	15,9	310×249×423
ECP 40-150F 250(N)	●	●	281	250	125	226	113	212	382	312	242	79	40	84	100/110	150	14/19	4	17,2	15,9	310×249×423
ECP 50-80F 240(N)	●	●	276	240	120	226	113	248	387	312	242	93	50	102	110/125	164	14/19	4	18,7	17,4	305×285×428
ECP 50-120F 280(N)	●	●	296	280	140	226	113	248	389	312	242	93	50	102	110/125	164	14/19	4	19	17,5	325×285×430
ECP 50-180F 280(N)	●	●	296	280	140	226	113	248	389	312	242	93	50	102	110/125	164	14/19	4	19,7	18,2	325×285×430
ECP 65-100F 340(N)	●	●	326	340	170	226	113	266	399	320	250	90	65	119	130/145	185	14/19	4	23,1	21,3	355×303×440
ECP 65-150F 340(N)	●	●	326	340	170	226	113	266	399	320	250	90	65	119	130/145	185	14/19	4	25,8	24	355×303×440
ECP 80-120F 360	●		336	360	180	226	113	326	426	326	256	111	80	128	150/160	200	19	8	30	28,2	365×363×467

Rev. 01/2025



Dudullu Organize Sanayi Bölgesi 2. Cadde No: 14
34775 Ümraniye İstanbul / Turkey
Tel : +90 216 561 47 74 (Pbx) • Fax : +90 216 561 47 50
www.etna.com.tr/en • info@etna.com.tr



ETNA®